

Quick reference guide

Manual coating equipment

OptiFlex 2 W

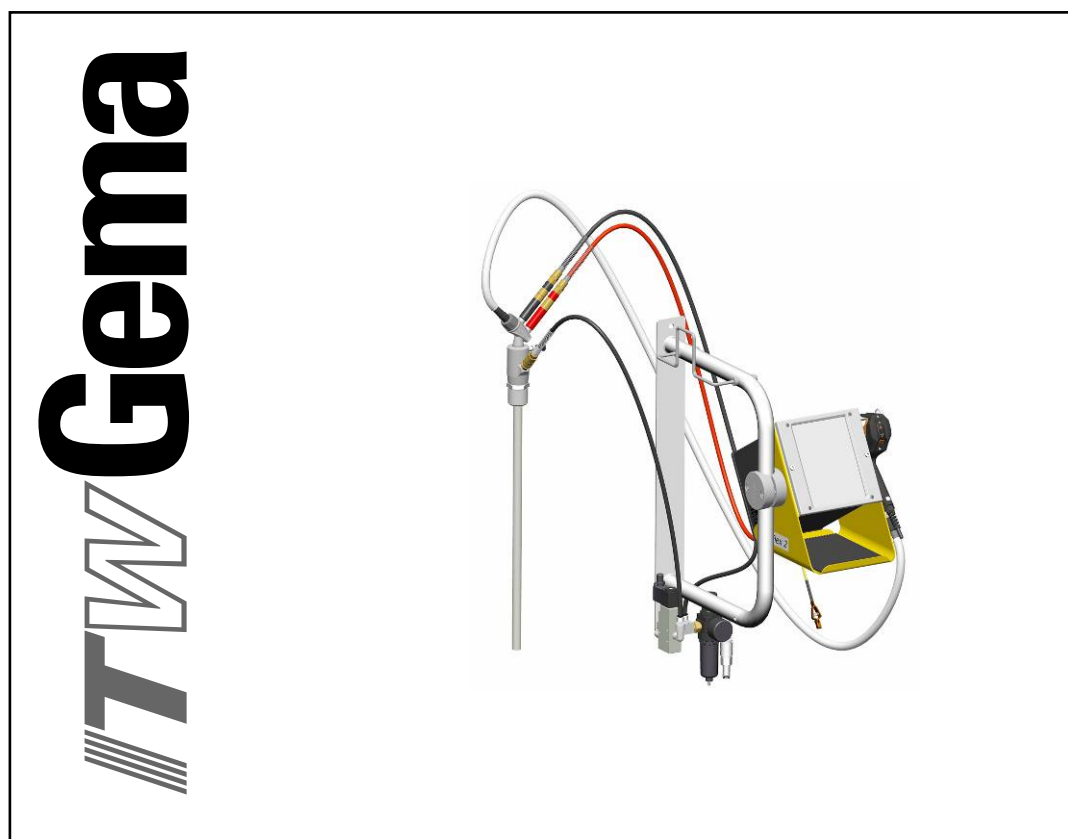

Translation of the original operating instructions

Documentation OptiFlex 2 W

© Copyright 2010 ITW Gema GmbH

All rights reserved.

This publication is protected by copyright. Unauthorized copying is prohibited by law. No part of this publication may be reproduced, photocopied, translated, stored on a retrieval system or transmitted in any form or by any means for any purpose, neither as a whole nor partially, without the express written consent of ITW Gema GmbH.

OptiFlex, OptiTronic, OptiGun, EasyTronic, EasySelect, EasyFlow, OptiStar, OptiSelect, OptiFlow and SuperCorona are registered trademarks of ITW Gema GmbH.

OptiMatic, OptiMove, OptiMaster, OptiPlus, PowerClean, Precise Charge Control (PCC), MultiTronic and Gematic are trademarks of ITW Gema GmbH.

All other product names are trademarks or registered trademarks of their respective holders.

Reference is made in this manual to different trademarks or registered trademarks. Such references do not mean that the manufacturers concerned approve of or are bound in any form by this manual. We have endeavored to retain the preferred spelling of the trademarks, and registered trademarks of the copyright holders.

To the best of our knowledge and belief, the information contained in this publication was correct and valid on the date of publication. ITW Gema GmbH makes no representations or warranties with respect to the contents or use of this publication, and reserves the right to revise this publication and make changes to its content without prior notice.

Printed in Switzerland

ITW Gema GmbH
Mövenstrasse 17
9015 St.Gallen
Switzerland

Phone: +41-71-313 83 00

Fax.: +41-71-313 83 83

E-Mail: info@itwgema.ch

Homepage: www.itwgema.ch

Table of contents

General safety regulations	3
OptiFlex 2 W	9
Technical data	11
Start-up	14
Initial start-up.....	17
Operation	19
Color change.....	25
Cleaning and maintenance	29
Troubleshooting	33
Spare parts list	35
OptiFlex 2 CG09	39
Troubleshooting	43
Spare parts list	45
OptiFlex 2 GM03	47
Cleaning and maintenance	51
Troubleshooting	55
Spare parts list	57
OptiFlow injector	68
Cleaning and maintenance	70
Troubleshooting guide	72
Spare parts list	73

General safety regulations

This chapter sets out the fundamental safety regulations that must be followed by the user and any third parties using OptiFlex 2 W manual coating equipment.

These safety regulations must be read and understood in full before the OptiFlex 2 W is put into operation.

Safety symbols (pictograms)

The following warnings with their meanings can be found in the ITW Gema operating instructions. The general safety precautions must also be followed as well as the regulations in the operating instructions.

**DANGER!**

Danger due to live electricity or moving parts. Possible consequences: death or serious injury

**WARNING!**

Improper use of the equipment could damage the machine or cause it to malfunction. Possible consequences: light injuries or damage to the equipment

**INFORMATION!**

Useful tips and other information



General information

The OptiFlex 2 W Manual coating equipment is built to the latest specification and conforms to the recognized technical safety regulations. It is designed for the normal application of powder coating.

Any other use is considered non-compliant. The manufacturer shall not be liable for damage resulting from any such non-compliant use and the user shall bear sole responsibility for such actions. If the OptiFlex 2 W Manual coating equipment is to be used for other purposes or other substances outside of our guidelines, then ITW Gema GmbH should be consulted.

Observance of the operating, service and maintenance instructions specified by the manufacturer is also part of conformity of use.

The relevant accident prevention regulations, as well as other generally recognized safety regulations, occupational health and structural regulations are to be observed.

Furthermore, the country-specific safety regulations also must be observed.

Additional safety and operation notices can be found on the accompanying CD or on the homepage www.itwgema.ch.



General dangers

The start-up is forbidden until it has been established that the OptiFlex 2 W Manual coating equipment has been set up and wired according to the EU guidelines for machinery.

Unauthorized modifications to the OptiFlex 2 W Manual coating equipment exempts the manufacturer from any liability from resulting damages or accidents.

The operator must ensure that all users have received appropriate training for powder spraying equipment and are aware of the possible sources of danger.

Any operating method, which will negatively influence the technical safety of the powder spraying equipment, is to be avoided.

For your own safety, only use accessories and attachments listed in the operating instructions. The use of other parts can lead to risk of injury. Only original ITW Gema spare parts should be used!

Repairs must only be carried out by specialists or by authorized ITW Gema service centers. Unauthorized conversions and modifications can lead to injuries and damage to the equipment and invalidate the ITW Gema GmbH guarantee.



Electrical
danger

The connecting cables between the control unit and the spray gun must be installed so as to eliminate the possibility of damage during the operation. Safety precautions specified by local legislation must be observed!

The plug connections between the powder spraying equipment and the mains should only be removed when the power supply is switched off.

All maintenance activities must take place when the powder spraying equipment is switched off.

The powder coating equipment may not be switched on until the booth is in operation. If the booth stops, the powder coating device must switch off too.



Explosion hazard

The control units for the spray guns must be installed and used in zone 22. Spray guns are allowed in zone 21.

Only original ITW Gema OEM parts are guaranteed to maintain the explosion protection rating. If damages occur related to the use of spare parts from other manufacturers, all relevant warranty or compensation claims are void!

Conditions leading to dangerous levels of dust concentration in the powder spraying booths or in the powder spraying areas must be avoided. There must be sufficient technical ventilation available, to prevent a dust concentration of greater than 50% of the lower explosion limit (UEG = max. permissible powder/air concentration). If the UEG is not known, then a value of 10 g/m³ should be considered (see EN 50177).

All unauthorized conversions and modifications to the electrostatic spraying equipment are forbidden for safety reasons.

The safety devices may not be dismantled or put out of operation.

Mandatory operational and workplace notices from the operating company must be written in a comprehensible manner in the language of equipment operators and posted in a suitable place.



Slip hazard

Powder lying on the floor around the powder spraying equipment is a potentially dangerous source of slipping. Booths may be entered only in the places designed for this purpose.

Static charges

Static charges can have the following consequences: Charges to people, electric shocks, sparking. Proper grounding must be in place to prevent objects from becoming charged.



Observe the grounding regulations

Grounding

All electrically conductive parts found within 5 meters around each booth opening, and in particularly the objects to be coated, must be grounded. The grounding resistance of each object must amount to maximally 1 MOhm. This resistance must be checked/tested regularly when starting work.

The condition of the work piece attachments, as well as the hangers, must guarantee that the work pieces remain grounded. The appropriate measuring devices must be kept ready in the workplace, in order to check the grounding.

The floor of the coating area must conduct electricity (normal concrete is generally conductive).

The supplied grounding cable (green/yellow) must be connected to the grounding screw of the electrostatic manual powder coating equipment. The grounding cable must have a good metallic connection with the coating booth, the recovery unit and the conveyor chain, respectively with the suspension arrangement of the objects.



Fire and smoke prohibition

Smoking and open flames are forbidden in the entire plant area! No work that could potentially produce sparks is allowed!



The stay for persons with cardiac pacemakers is forbidden

As a general rule for all powder spraying installations, persons with pacemakers should never enter high voltage areas or areas with electromagnetic fields. Persons with pacemakers should not enter areas with powder spraying installations!



Photographing with flashlight is forbidden

Photographing with flashlight can lead to unnecessary releases and/or disconnections by safety devices.



Disconnect from mains before maintenance works take place

Disconnect the plugs before the machines are opened for maintenance or repair.

The plug connections between the powder spraying equipment and the mains should only be removed when the power supply is switched off.



As far as it is necessary, the operating firm must ensure that the operating personnel wear protective clothing (e.g. facemasks).

A dust mask corresponding to filter class FFP2 at minimum must be worn during any cleaning work.



The operating personnel must wear electrically conductive, steel-toe footwear (e.g. leather soles).



The operating personnel should hold the gun with bare hands. If gloves are worn, these must also conduct electricity.

These general safety regulations must be read and understood in all cases prior to start-up!

OptiFlex 2 W

Note:

For further information, see the corresponding operating manual, which can be found on the accompanying CD.

Structure

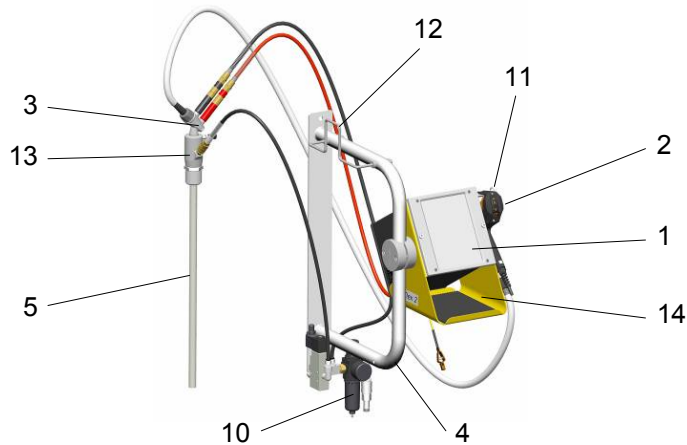

OptiFlex 2 W manual coating equipment - Structure

- | | | | |
|---|-----------------------------------|----|-------------------|
| 1 | OptiFlex 2 CG09 control unit | 10 | Filter unit |
| 2 | OptiFlex 2 GM03 manual powder gun | 11 | Gun holder |
| 3 | OptiFlow injector | 12 | Hose holder |
| 4 | Wall bracket | 13 | PowerClean module |
| 5 | Suction tube | 14 | Shelf |

Scope of delivery

- OptiFlex 2 CG09 control unit in a metal case with power supply cable
- Wall bracket with gun/hose holder filter unit
- Suction tube
- plug-in OptiFlow injector
- OptiFlex 2 GM03 manual powder gun with gun cable, powder hose, rinsing air hose and standard nozzle set (For more on this, see the operating manual for the OptiFlex 2 GM03 manual powder gun)
- Pneumatic hoses for conveying air (red), supplementary air (black), fluidizing air (black) and rinsing air (black)
- Operating manual
- Short instructions

Technical data

OptiFlex 2 W

Connectable guns



OptiFlex 2 F	connectable
OptiFlex 2 GM03	yes



Warning:

The OptiFlex F manual coating equipment can only be used with the specified gun type!

Electrical data

OptiFlex 2 W	
Nominal input voltage	100-240 VAC
Frequency	50 -60 Hz
Connected load	40 VA
Nominal output voltage (to the gun)	eff. 10 V
Nominal output current (to the gun)	max. 1.2 A
Connection and output for vibrator (on Aux output)	110/230 VAC max. 100 W
Connection for rinsing function (valve)	24 VDC max. 3 W
Temperature range	0 °C - +40 °C (+32 °F - +104 °F)
Max. surface temperature	100 °C (+212 °F)
Approvals	  II 3 D IP54 100 °C

Pneumatic data

OptiFlex 2 W	
Max. input pressure	10 bar
Min. input pressure	6 bar
Input pressure (Dynamic based on pressure regulator setting)	5.5 bar / 80 psi
Max. water vapor content of the compressed air	1.3 g/m ³
Max. oil vapor content of the compressed air	0.1 mg/m ³
Max. compressed air consumption	8 Nm ³ /h

Dimensions

OptiFlex 2 W	
Width	333 mm
Depth	460 mm
Height	697 mm
Weight	13 kg

Processible powders

OptiFlex 2 W	
Plastic powder	yes
Metallic powder	yes
Enamel powder	no



Powder output (guide values)

General conditions for the OptiFlow Injector

Powder type	Epoxy/polyester
Powder hose length (m)	6
Powder hose Ø (mm)	10
Powder hose type	POE with guide strips
Input pressure (bar)	5,5
Conveying air nozzle Ø (mm)	1,6
Correction value C0	Powder output zeroing adjustment

Guide values for OptiFlex 2 CG09 with the OptiFlow IG06 injector

All values in these tables are guide values. Differing environmental conditions, wear and different powder types can affect the table values.

Total air 		3 Nm ³ /h	4 Nm ³ /h	5 Nm ³ /h
		Powder output (g/min)		
Powder output  (%)	20	85	100	120
	40	150	185	210
	60	210	255	280
	80	270	320	350
	100	300	360	395

Air flow rates

The total air consists of conveying air and supplementary air, in relation to the selected powder quantity (in %). As a result the total air volume is maintained constant.

OptiFlex 2 CG09	Range	Factory setting
Flow rate - fluidizing air - OptiFlex F (without AirMover air requirements)	0-5.0 Nm ³ /h	1.0 Nm ³ /h
Electrode rinsing air flow rate	0-3.0 Nm ³ /h	0.1 Nm ³ /h
Flow rate total air (at 5.5 bar)	1.8-6.5 Nm ³ /h	



Note:

The total air consumption for the device is determined for each device type based on the 3 configured air values (without AirMover air value for OptiFlex F).

These values apply for an internal control pressure of 5.5 bar!

Start-up

Connection instructions

The OptiFlex 2 W manual coating equipment must be connected in accordance with the setup and connection instructions (Please also review the operating instructions for the OptiFlex 2 CG09 manual gun control unit).

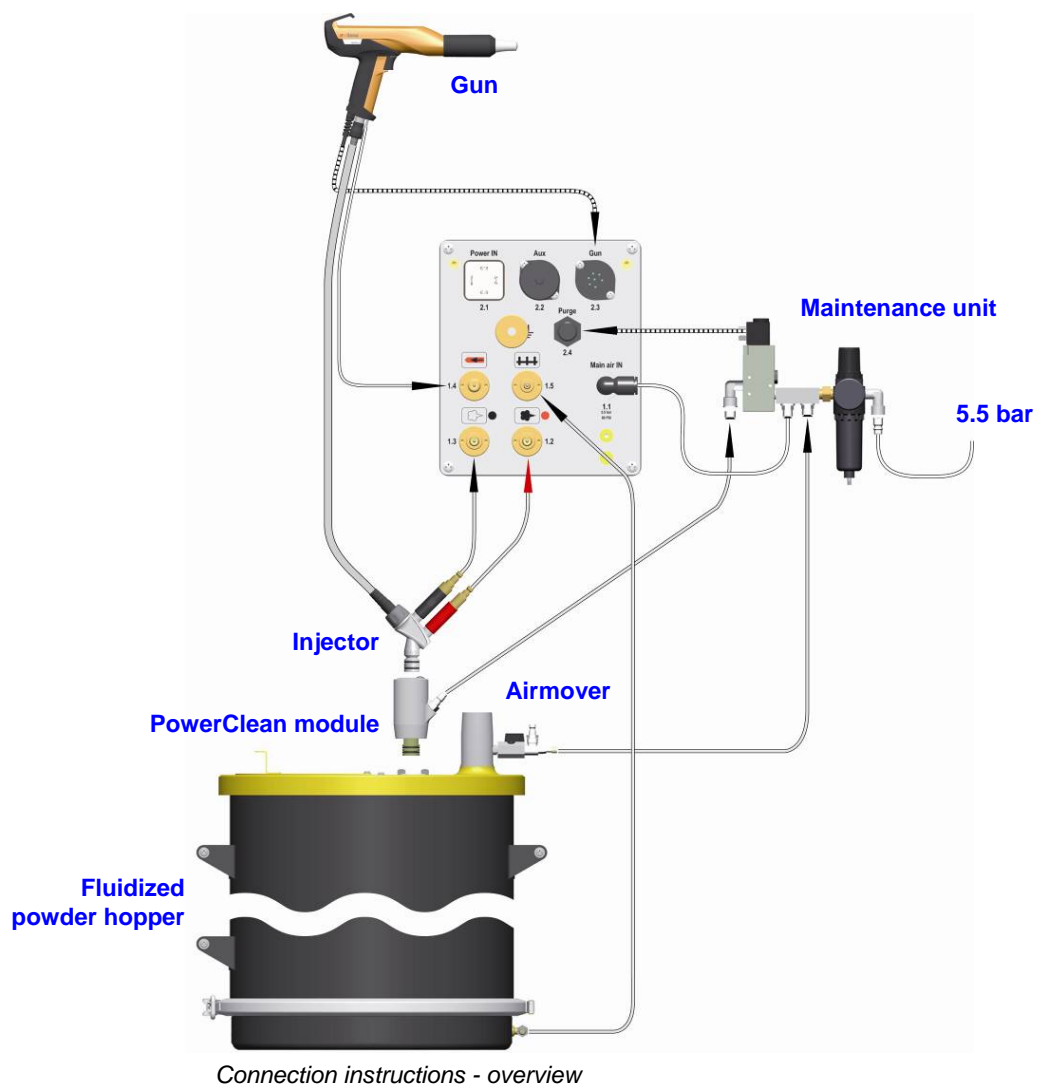





Note:
The compressed air must be free of oil and water!

Connections

Compressed air hoses / cables



Connections – Compressed air hoses / cables

Connection	Description
1.1 Main air IN	Connection compressed air (5.5 bar / 80 PSI)
2.1 Power IN	Mains cable connection (100-240 VAC)
2.2 Aux	Vibration motor connection for OptiFlex B
2.3 Gun	Gun cable connection
2.4 Purge	Connection to rinsing module
1.5	Fluidizing air connection 
1.4	Electrode rinsing air connection 
1.3	Supplementary air connection 
1.2	Conveying air connection 
	Grounding connection 

Pin assignment

Power IN

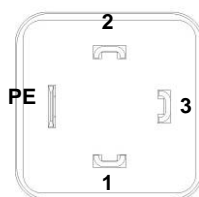

Power IN connection

- 1 Neutral conductor (power supply)
- 2 Phase (100-240 VAC)
- 3 Output vibrator or stirrer
- PE Grounding PE

Initial start-up



Note:

If a malfunction occurs, see the troubleshooting guide, as well as the gun control unit operating manual!

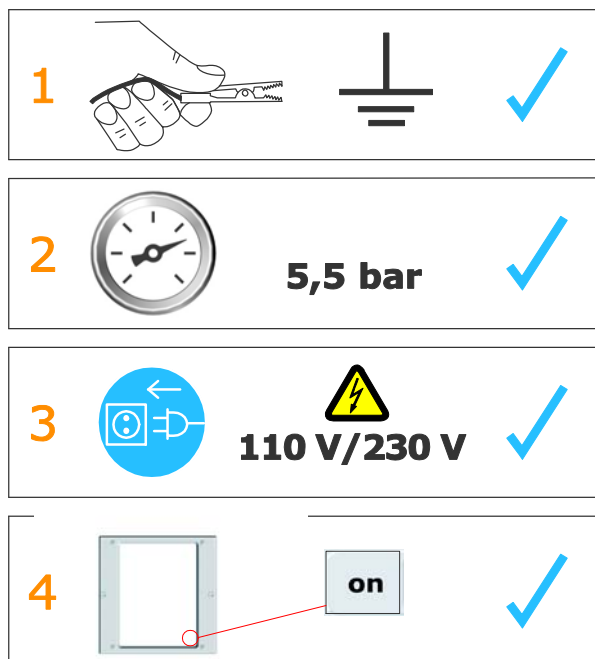

Note:

The remainder of the start-up procedure for the OptiFlex 2 GM03 manual powder gun is explicitly described in the operating instructions for the OptiFlex 2 CG09 manual powder gun control unit (chapter "Initial start-up" and "Daily start-up")!

Setting the device type



Note:

If the control unit is delivered as an integral component of an OptiFlex apparatus, then the system parameters will have been factory preconfigured for optimal use (For more on this, please also see the operating instructions for the OptiFlex 2 CG09 manual gun control unit!).



NOTE!

The manual gun control unit always starts up to the last configured settings.

Operation

Coating



DANGER!

During the coating process, the gun can discharge along the body of the coating person if not held using its intended handle, which has been grounded

- Always hold gun only by the handle!
 - Do not touch any other parts of the gun!
-



WARNING:

If the manual equipment is not being used for coating in conjunction with a sufficiently powerful suction unit, then the stirred-up dust from the coating powder can cause respiratory issues or cause a slippage/falling hazard.

- The manual equipment may only be operated in conjunction with a sufficiently powerful suction unit (such as Gema Classic Open booth).
-

1. Turn on the gun control unit with the **ON** key
The displays illuminate and the control unit is ready for operation
 2. Place powder hopper on the mobile trolley
-





WARNING:

When setting the powder hopper onto the mobile trolley of the manual equipment, the hopper/trolley zone represents a threat of crushed toes

- Wear safety shoes with steel toecaps
-

3. Set the ventilation (Airmover)
 - a) Open the ball valve completely
 - b) Calibrate with the throttle valve
4. Fill in powder
 - a) Open the powder hopper filling cover
 - b) Fill with maximum 25 kg (50 l) powder or the powder must reach to a maximum of 5-10 cm below the handles of the powder hopper, otherwise the fluidized powder can escape from the cover

- c) Close the filling cover of the powder hopper again
- 5. Set coating parameters:
- 6. Press the application button for the appropriate preset mode:

flat parts	
complicated parts	
overcoat	

The arrow above the desired button lights up



OR

- 7. Press  program key
- c) Select desired program (01-20)

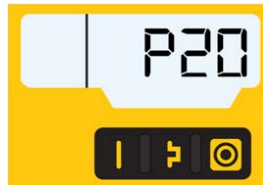





- d) Change coating parameters as required



Note:

Programs 01-20 are preset at the factory but can be modified at any time, after which they are automatically stored.

Description	Presetting
Powder output 	50%
Total air 	4.0 Nm³/h
High voltage <i>kV</i>	80 kV
Spray current <i>µA</i>	80 µA
Electrode rinsing air 	0.1 Nm³/h
Fluidizing air 	0.1 Nm³/h (for OptiFlex-B and S)

- 8. Setting the total air volume





correct powder cloud



too little total air

**Note:**

A total air volume of 4 Nm³/h and a 50% powder share are recommended as the base values.

9. Adjust the powder output volume (e.g. according to the desired coating thickness)



or



much powder



little powder

**Note:**

To achieve maximum efficiency, we recommend avoided an overly high powder volume where possible! The standard setting of 50% and a total air volume of 4 Nm³/h is recommended at the start. The total air volume is thereby kept constant automatically by the control unit.

If values are entered that the equipment cannot implement, then the operator is informed of this by a blinking in the relevant display and a temporary error message!

10. Setting the electrode rinsing air

- a) Press the key

sel

The second display level will be shown

- b)



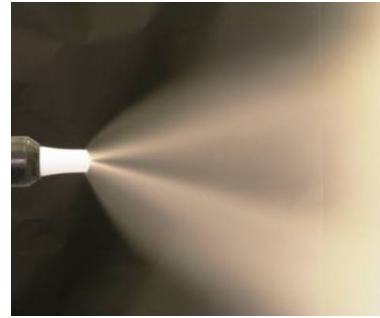
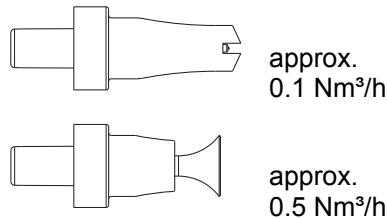

too much electrode rinsing air

11. Setting the fluidization

- a) Press the key  The second display level will be shown



- c) Check the powder fluidization in the powder container
The powder fluidization in the powder containers depends on the powder characteristics, the humidity and the ambient air temperature. Fluidizing and vibration start by switching on the control unit.



WARNING:

If the ventilation has been incorrectly adjusted, then the coating powder can create a dust cloud capable of causing respiratory problems.

- Ensure proper setting of ventilation

12. Point the gun into the booth (not at the object to be coated), press the gun trigger and visually check the powder output
13. Check whether everything is functioning correctly
14. Coating
15. Adjust the coating parameters as necessary
16. Activate the rinsing function periodically



Note:

It prevents the bridging phenomena that can lead to short circuiting when handling powders such as metallic powders.

In moist or tropical environments, any moisture is driven from the injector, powder hose and powder gun.

- a) 
- The LCD segments begin to move on the CG09 display



Note:
The PowerClean function can be stopped as required using the P key.



Procedure	Effect
automatic	<ul style="list-style-type: none"> - The automatic rinsing process is started - Injector, powder hose, gun and spray nozzle are purged using compressed air - The automated PowerClean function enables parallel cleaning of other components, such as the fluid intake unit, powder container, etc.
manual	<ul style="list-style-type: none"> - The operator controls the number and length of the PowerClean impulse by pressing the pistol trigger a second time

After completion of the PowerClean procedure, the controller switches back to coating mode.

Color change

General information

When a color change takes place, the individual components of the manual coating equipment must be cleaned carefully. All powder particles of the former color must be removed during this process!

The following describes an 'extreme' color change (light to dark).

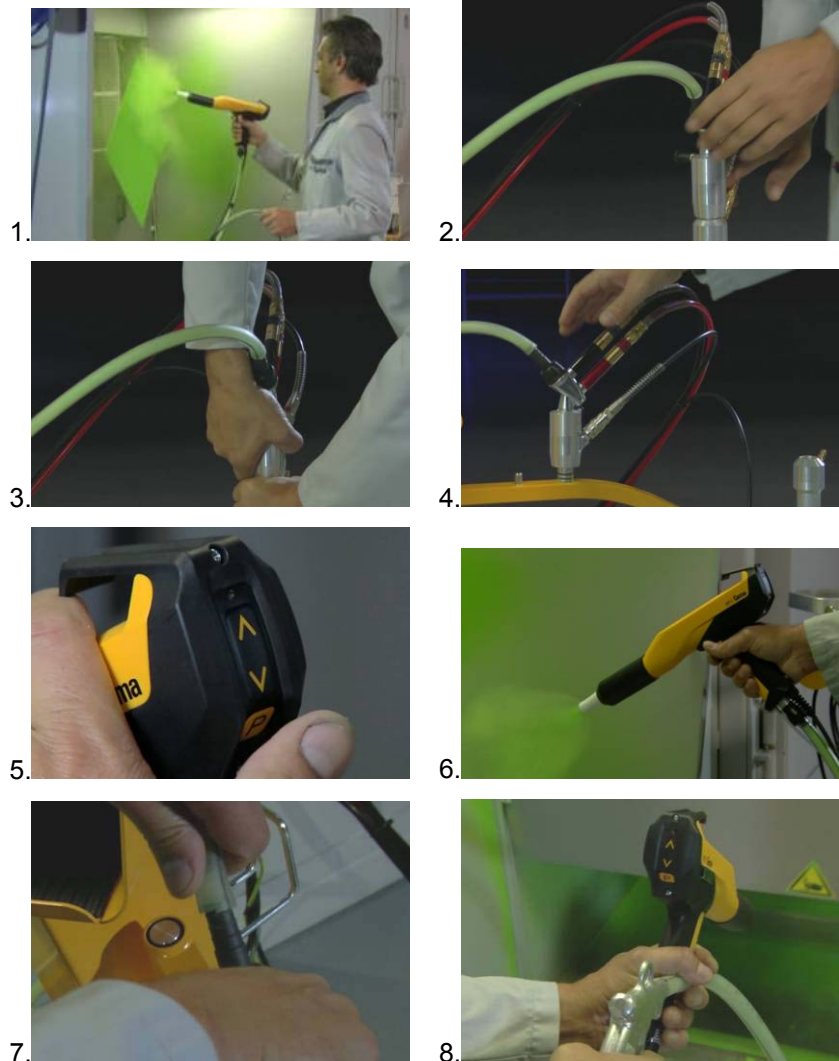



9.

Remove and clean the nozzle, purge gun using air

10.



11.



12.



13.



14.

15. Separate fluidized air cable

16. Remove cover, purge with compressed air and clean with a clean, dry brush and cloth

17. Clean suction intake pipe

18. Empty remaining powder into a container

19. Vacuum up container and in particular the bottom

20. Clean container with a cloth

21. Reconstruct the powder container

22. Fill with new powder



23.



24.



25.

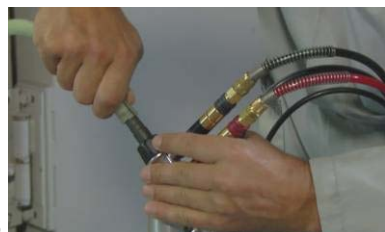

26.



Shutdown



1. Release gun trigger
2. Switch off the control unit

Note:

The adjustments for high voltage, powder output, electrode rinsing air and fluidizing remain stored!

If in disuse for several days

1. Separate from power mains
2. Clean the coating equipment (see the corresponding operating manual)
3. Turn off the compressed air main supply

Cleaning and maintenance



Note:

Regular and conscientious maintenance increases the service life of the OptiFlex 2 W manual coating equipment and provides for a longer continuous coating quality!

The parts, which are to be replaced during maintenance work, are available as spare parts. These parts will be found in the corresponding spare parts list!

Daily maintenance

1. Clean the injector (see therefore the user manual of the OptiFlow injector)
2. Clean the powder gun (For more on this, please also review the user manual for the OptiFlex 2 GM03 manual powder gun)
3. Clean the powder hose; Please also review the section "Color change"

Weekly maintenance

1. Clean fluidizing/suction unit, injector, rinsing module and powder gun. The fluidizing/suction unit is placed back into the powder shortly before restarting operation
2. Check the control unit grounding connections to the coating booth, the suspension devices of the work pieces, or the conveyor chain

If in disuse for several days

1. Separate from power mains
2. Clean the coating equipment
3. Turn off the compressed air main supply

Powder hose rinsing

If longer downtimes take place, the powder hose has to be cleaned.

Procedure:

1. Disconnect the powder hose from the hose connection on the injector
2. Point the gun into the booth
3. Blow through the hose manually with a compressed air gun
4. Connect the powder hose again to the hose connection on the injector

Cleaning



WARNING:

If no dust mask or one of an insufficient filter class is worn when cleaning the manual equipment, then the dust that is stirred up from the coating powder can cause respiratory problems.

- The ventilation system must be turned on for all cleaning work.
- A dust mask corresponding to filter class FFP2 at minimum must be worn during any cleaning work.

Cleaning the powder container

1. Separate fluidized air cable
2. Remove the injector
3. Remove rinsing module
4. Remove cover, purge with compressed air and clean with a clean, dry brush and cloth
5. Clean the injector and suction intake pipe (Please review injector manual for more on this)
6. Clean rinsing module
7. Empty remaining powder into a container
8. Vacuum up container and in particular the bottom
9. Clean container with a cloth
10. Reconstruct the powder container



Note:

**Do not refill the powder container until just before the next use!
Never clean the powder container with solvents or water!**

Cleaning the OptiFlex 2 GM03 manual powder gun

Frequent cleaning of the gun helps to guarantee the coating quality.



Note:

Before cleaning the powder gun, switch off the control unit. The compressed air used for cleaning must be free of oil and water!

Daily:

1. Blow off the outside of the gun and wipe, clean etc.

Weekly:

2. Remove the powder hose from the connection
3. Remove the spray nozzle from the gun and clean it
4. Blow out the gun from the connection in flow direction with compressed air

5. Clean the integrated gun tube with the provided gun brush
6. Blow through the gun with compressed air again
7. Clean the powder hose
8. Reassemble the gun and connect it



Note:

Please also review the user manual for the OptiFlex 2 GM03 manual powder gun!

Troubleshooting

General information

Note:

Prior to any troubleshooting measures, always check whether the equipment parameters (P0) as configured in the control unit are correct (See operating instructions for the OptiFlex 2 CG09 manual gun control unit, Chapter "Initial Start-up – Setting Equipment Type")

Fault	Causes	Troubleshooting
Control unit displays remain dark, although the control unit is switched on	Control unit is not connected to the mains	Connect the equipment with the mains cable
	Power pack fuse defective	Replace the fuse
	Power pack defective	Contact local Gema representative
The gun does not spray powder, although the control unit is switched on and the gun trigger is pressed	Compressed air not present	Connect the equipment to the compressed air
	Injector, throttle motor or nozzle on injector, powder hose or powder gun are clogged	Clean the corresponding part
	Insert sleeve in the injector is clogged	Replace
	Insert sleeve is not installed	Mount insert sleeve
	Fluidization not running	see below
	Total air incorrectly configured	Set total air correctly (Default value 4 Nm ³ /h)
	Main valve defective	Replace main valve
Gun LED remains dark, although the gun is triggered	Gun not connected	Connect the gun
	Gun plug, gun cable or gun cable connection defective	Contact local Gema representative
	Remote control on powder gun defective	Contact local Gema representative

Fault	Causes	Troubleshooting
Powder does not adhere to object, although the gun is triggered and sprays powder	The objects are improperly or insufficiently grounded	Check grounding, reground at better quality
	High voltage and current deactivated	Press the selection key (application key)
	High voltage cascade defective	Contact local Gema representative
The powder is not fluidized	Compressed air not present	Connect the equipment to the compressed air
	Fluidizing air is set too low on the control unit	Set the fluidizing air correctly
	Throttle motor defective	Contact local Gema representative
No electrode rinsing air	Rinsing air throttle motor defective	Contact local Gema representative

Spare parts list

Ordering spare parts

When ordering spare parts for powder coating equipment, please indicate the following specifications:

- Type and serial number of your powder coating equipment
- Order number, quantity and description of each spare part

Example:

- **Type** OptiFlex 2 W
Serial number 1234 5678
- Order no. 203 386, 1 piece, Clamp - Ø 18/15 mm

When ordering cable or hose material, the required length must also be given. The spare part numbers for this kind of bulk stock is always marked with an *.

Wearing parts are always marked with a #.

All dimensions of plastic hoses are specified with the external and internal diameter:

Example:

Ø 8/6 mm, 8 mm outside diameter (o/d) / 6 mm inside diameter (i/d)



WARNING!

Only original ITW Gema spare parts should be used, because the explosion protection will also be preserved that way. The use of spare parts from other manufacturers will invalidate the ITW Gema guarantee conditions!

OptiFlex 2 W manual coating equipment – Spare Parts

1	CG09 gun control unit - complete (see corresponding operating manual)	1007 018
2	GM03 manual powder gun - complete (see corresponding user manual)	1008 070
3	IG06 injector - complete (see corresponding user manual)	1007 780
4	Pneumatic connection for conveying air	
4.1	Quick release connection - NW5, Ø 8 mm, red	261 645
4.2	Nut with kink protection – M12x1 mm, Ø 8 mm	201 316
4.3	Plastic tube - Ø 8/6 mm, red	103 500*
5	Pneumatic connection for supplementary air	
5.1	Quick release connection - NW5, Ø 8 mm, black	261 637
5.2	Nut with kink protection – M12x1 mm, Ø 8 mm	201 316
5.3	Plastic tube - Ø 8/6 mm, black, with white strip marking	1008 038*
6	Rinsing module – complete (See operating instructions OptiFlex 2 GM03 manual powder gun)	1007 362
7	Pneumatic connection for PowerClean air	
7.1	Quick release connection - NW5, Ø 8 mm	1008 027
7.2	Plastic tube - Ø 8/6 mm, black	103 152*
8	Suction tube - complete	339 130
9	Grounding cable - complete	301 140
10	Pneumatic group - complete (see corresponding spare parts list)	
11	Quick release connection - NW7.8 - Ø 13 mm	243 647
12	Locknut - PG21	234 869
14	Powder hose – Ø 15/10 mm, 6m	1001 673
15	Short instructions	1007 143
16	Operating manual	1007 141

* Please indicate length

OptiFlex 2 W manual coating equipment – Spare Parts

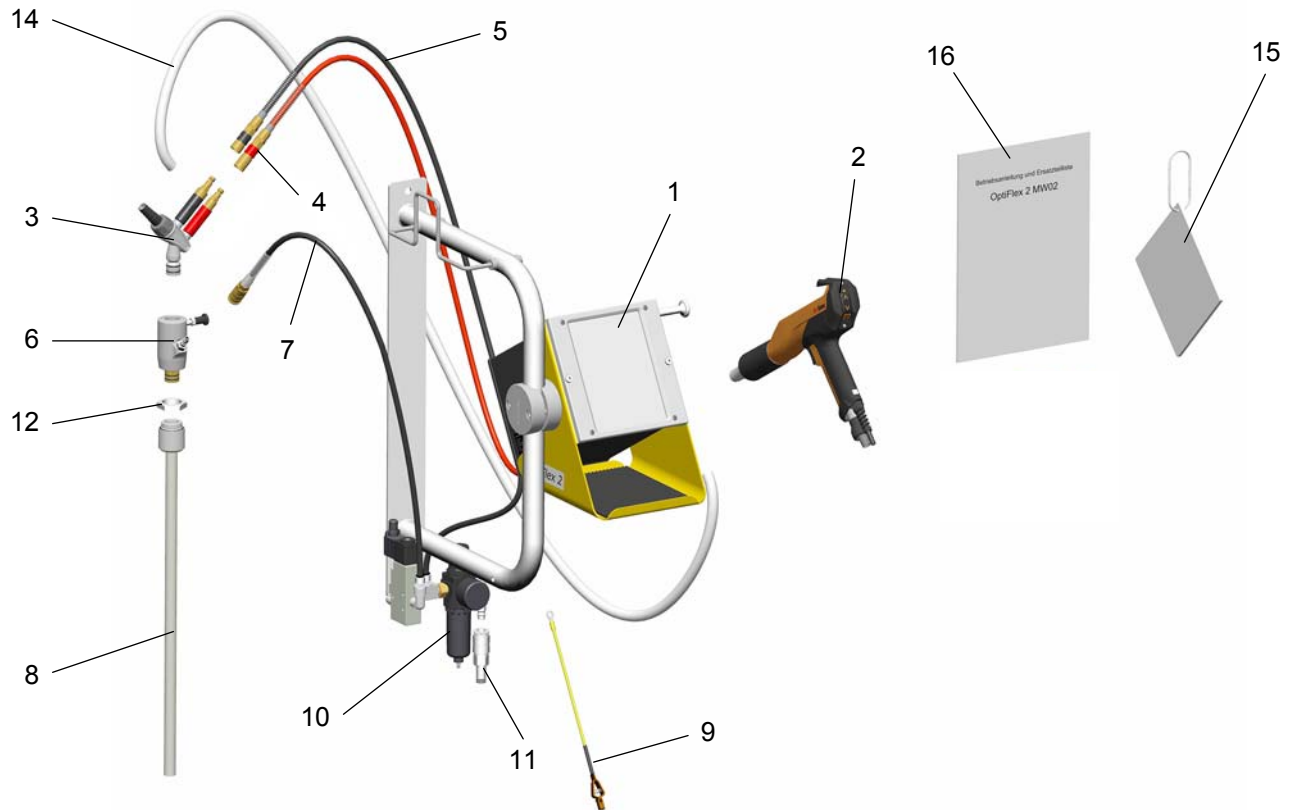

OptiFlex 2 W manual coating equipment – Spare Parts

OptiFlex 2 W - Pneumatic group

	Pneumatic group - complete	1007 120
1	Filter cartridge - 20 µm	1007 325

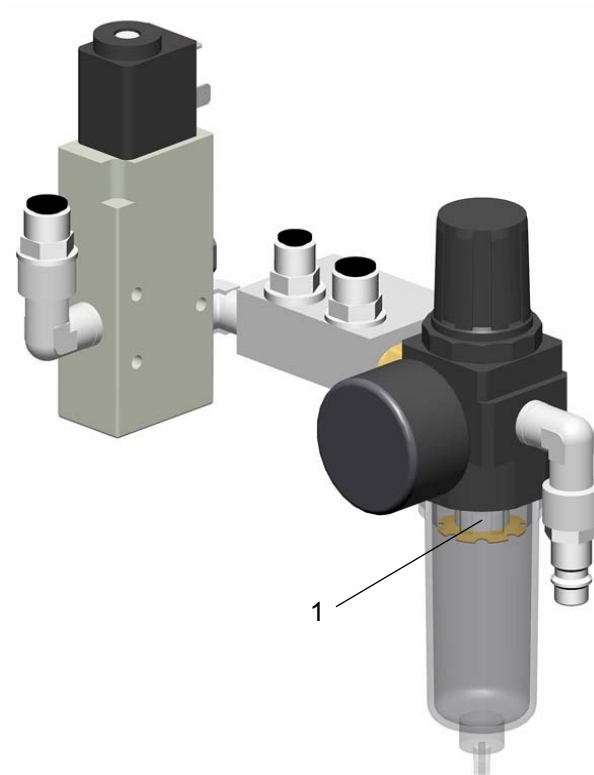

OptiFlex 2 W - Pneumatic group

OptiFlex 2 CG09

Note:

For further information, see the corresponding operating manual, which can be found on the accompanying CD.

Structure

General view



- 1 Front plate with control and display elements
- 2 Enclosure

- 3 Back panel with interfaces

Operating elements

Display and input buttons



Note:

For easier operation of the control unit, the preset and actual values are distributed across several levels. The "sel" key is used to switch between the levels. If no controls are used within 6 s, the device automatically returns to level 1.

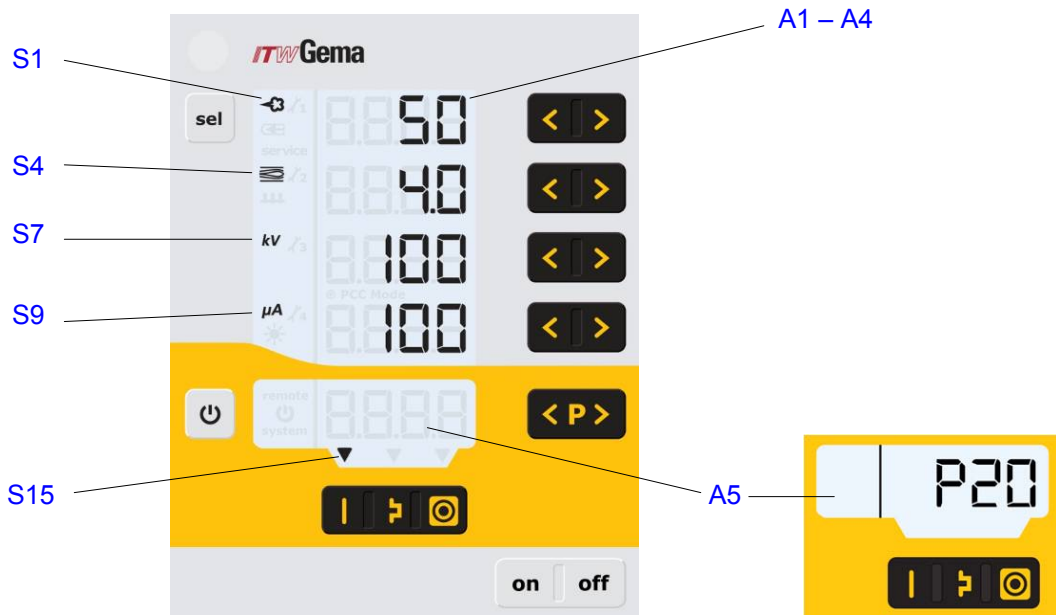

Displays, Level 1

Designation	Function
A1-A4	Display of actual values, preset values and system parameters
A5	Display of program numbers, error diagnosis codes and status information
S1	Powder output (display in %)
S4	Total air volume (display in Nm ³ /h)
S7	High voltage (display in kV)
S9	Spraying current (display in μA)
S4	Fluidizing (display in Nm ³ /h)
S6	Electrode rinsing air (display in Nm ³ /h)
S7	Activation of vibration/fluidization
S15	Application mode for flat parts is activated
S16	Application mode for complicated parts is activated
S17	Application mode for recoating parts already coated is activated

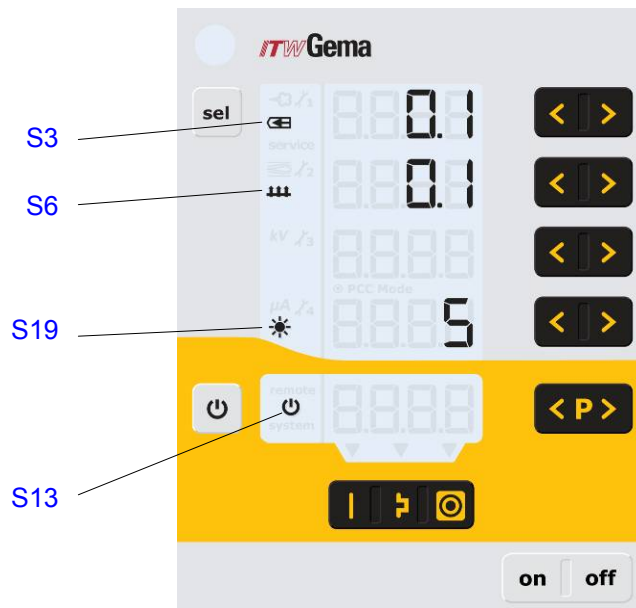

Displays and LEDs, Level 2

Designation	Function
S3	Electrode rinsing air display (in Nm ³ /h)
S6	Fluidizing air display (in Nm ³ /h)
S13	Activation of vibration/fluidization
S19	Display illumination (0-8)

Input keys and switches

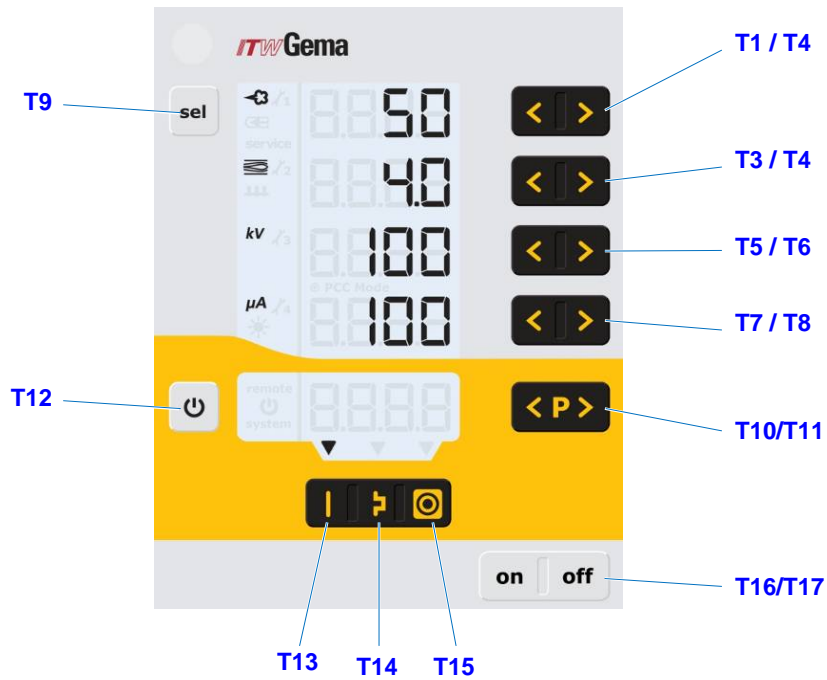

Input keys and switches

Designation	Function
T1-T8	Input keys for preset values and system parameters
T9 (Select)	Switch between display levels
T10-T11	Program change
T12	Switching on and off the fluidization (OptiFlex F) Switch on/off for vibration and fluidization (OptiFlex B) Switching on and off the stirrer (OptiFlex S) Switchover to system parameter mode (Press for at least 5 secs.)
T13	Preset mode for flat parts (fixed values)
T14	Preset mode for complex parts with depressions (fixed values)
T15	Preset mode for overcoating parts already coated (fixed values)
T16/T17	Power switch On/Off

Troubleshooting

Error diagnosis of the software

General information

The OptiFlex 2 CG09 manual gun control unit is constantly monitored for correct functionality. If the equipment software determines a fault, an error message is indicated with a help code. Following is monitored:

- High voltage technology
- Pneumatic system
- Power supply

Help codes

The error diagnosis codes (help codes) are shown in red on the **A5** display.



The help codes are stored in an error list in the order of their appearance. Each error in the list must be individually acknowledged with the keys **T10** or **T11**.

The errors are displayed in the order of their appearance. The **T10** and **T11** keys cannot be used for other functions, as long as an error code is still shown.

Here is a list of all possible error functions for the OptiFlex 2 CG09 manual gun control unit:

Code	Description	Criteria	Remedy
Pneumatics:			
H05	Purge valve	Valve defective, hardware defective	contact Gema Service
H06	Trigger valve	Valve defective, main board or cable defective	contact Gema Service
H07	Supplementary air flow too high (Setting of supplementary air on the display)	The preset value for supplementary air is too high compared to the conveying air setting	Lower supplementary air value or increase value for conveying air to equalize air volumes to the injector, delete error code

H08	Conveying air volume too high (setting of powder share on the display)	The preset value for conveying air is too high compared to the supplementary air setting	Lower conveying air value or increase value for supplementary air to equalize air volumes to the injector, delete error code
H09	Powder output higher than 100%	The powder output multiplied by the powder hose length factor and daily correction value is greater than 100% Daily correction value too large	Reduce powder output Reduce daily correction value
H10	Conveying air range lower deviation	The theoretical value for conveying air falls below minimum Total air is smaller than minimum	Limit conveying air to their minimum value
High voltage:			
H11		Gun error	contact Gema Service
H14		Grounded current measurement	contact Gema Service
Power supply:			
H20		Power pack defective or overloaded	contact Gema Service
H21		Power pack defective or overloaded	contact Gema Service
EEPROM (equipment memory):			
H24 - H27		EEPROM error	contact Gema Service
Throttle motors:			
H60 - H71		Throttle motor error	contact Gema Service

Help codes list

The last appeared four errors are stored in a list by the software. If an error appears, which is already in the list, he will not be listed again.

Appearance of errors

It is possible that an error is only displayed for a short time, but after the acknowledgement it will disappear. In this case, it's recommended to switch off the control unit and switch it on again (reset by restarting).

Spare parts list

Ordering spare parts

When ordering spare parts for powder coating equipment, please indicate the following specifications:

- Type and serial number of your powder coating equipment
- Order number, quantity and description of each spare part

Example:

- **Type** OptiFlex 2 W
Serial number 1234 5678
- Order no. 203 386, 1 piece, Clamp - Ø 18/15 mm

When ordering cable or hose material, the required length must also be given. The spare part numbers for this kind of bulk stock is always marked with an *.

Wearing parts are always marked with a #.

All dimensions of plastic hoses are specified with the external and internal diameter:

Example:

Ø 8/6 mm, 8 mm outside diameter (o/d) / 6 mm inside diameter (i/d)



WARNING!

Only original ITW Gema spare parts should be used, because the explosion protection will also be preserved that way. The use of spare parts from other manufacturers will invalidate the ITW Gema guarantee conditions!

OptiFlex 2 CG09 manual gun control unit

1	OptiFlex 2 CG09 manual gun control unit - complete	1007 018
2	Cover	1008 301



OptiFlex 2 CG09 manual gun control unit

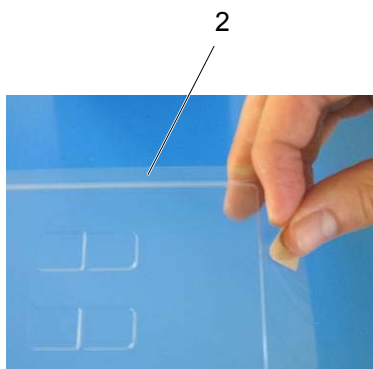



OptiFlex 2 GM03

Note:

For further information, see the corresponding operating manual, which can be found on the accompanying CD.

Technical data

Electrical data

OptiFlex 2 GM03	
Nominal input voltage	eff. 10 V
Frequency	18 kHz (average)
Nominal output voltage	100 kV
Polarity	negative (optional positive)
Max. output current	100 µA
High voltage display	with LED
Ignition protection	Ex 2 mJ T6
Temperature range	0 °C - +40 °C (+32 °F - +104 °F)
Max. surface temperature	85 °C (+185 °F)
Protection type	IP64
Approvals	  0102 II 2 D PTB11 ATEX 5006

Dimensions

OptiFlex 2 GM03	
Weight	520 g

Processible powders

OptiFlex 2 GM03	
Plastic powder	yes
Metallic powder	yes
Enamel powder	no

Structure

General view

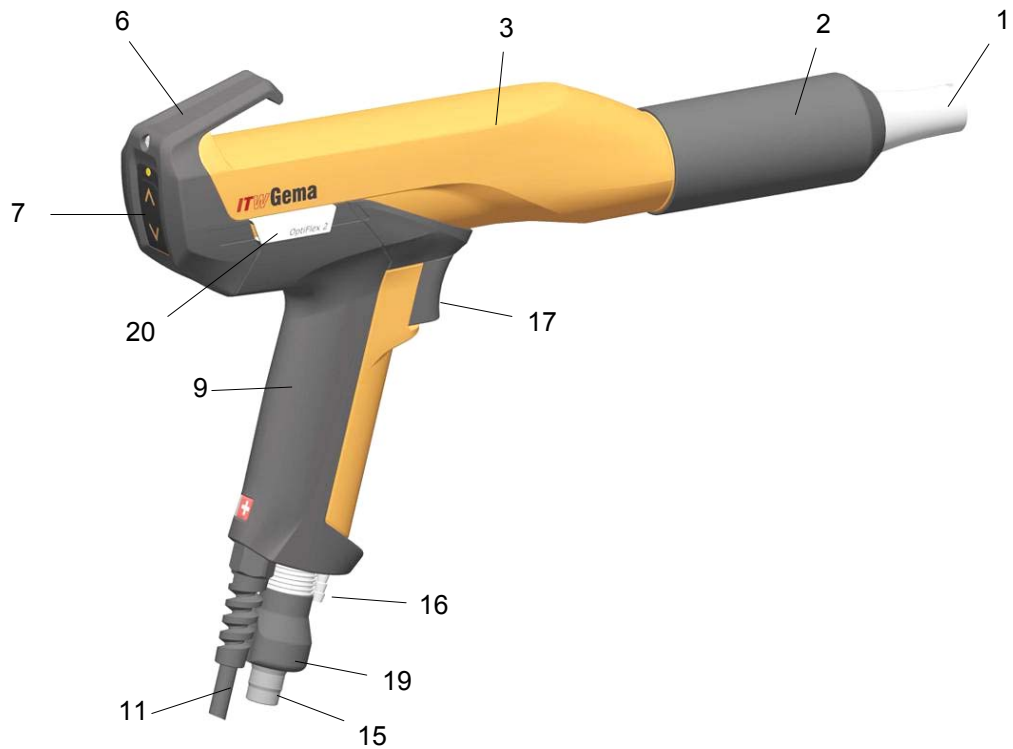

- | | | | |
|---|-------------------------------------|----|--------------------------------------|
| 1 | Spray nozzle system | 11 | Gun cable |
| 2 | Threaded sleeve | 15 | Powder hose connection |
| 3 | Shaft | 16 | Rinsing air connection |
| 6 | Cover with remote control and hooks | 17 | Trigger |
| 7 | Remote control | 19 | Powder hose quick release connection |
| 9 | Gun handle | 20 | SuperCorona - connection |

Operating elements

LED and remote control buttons



Operating elements

Designation	Function
L1	Display High voltage (intensity)
T1	Powder output + key
T2	Powder output - key
T3	Activate/stop rinsing process key

Scope of delivery

- OptiFlex 2 GM03 manual powder gun with gun cable (6 m), negative polarity
- Powder hose (6 m, ID 10 mm)
- Rinsing air hose (6 m)
- Flat jet nozzle NF20, complete (incl. electrode holder)
- Flat jet nozzle NF21
- Cable tie with Velcro closure
- Gun cleaning brush
- Spare parts kit
- Operating manual

Available accessories*

*for more information, see spare parts list

Cleaning and maintenance



NOTE!

Regular, careful cleaning and maintenance extends the service life of the OptiFlex 2 GM03 manual powder gun and ensures long-lasting, uniform coating quality!

The parts, which are to be replaced during maintenance work, are available as spare parts. These parts will be found in the corresponding spare parts list!

Cleaning

Cleaning the manual powder gun



NOTE!

Before cleaning the powder gun, switch off the control unit. The compressed air used for cleaning must be free of oil and water!

Daily:

1. Blow off the outside of the gun and wipe, clean etc.

Weekly:

2. Remove powder hose
3. Remove the spray nozzle from the gun and clean it with compressed air
4. Blow through the gun with compressed air, beginning from the connection in flow direction
5. Clean the integrated gun tube with the brush supplied, if necessary
6. Blow through the gun with compressed air again
7. Clean the powder hose
8. Reassemble the gun and connect it



WARNING

The following solvents may not be used to clean the OptiFlex 2 manual powder gun:

Ethylene chloride, acetone, ethyl acetate, methyl ethyl ketone, methylene chloride, premium gasoline, turpentine, tetrachloromethane, toluene, trichloroethylene, xylene!



NOTE!

Only cleaning agents with a flash point of a least 5 Kelvin above the ambient temperature, or cleaning places with technical ventilation are allowed!

Cleaning the spray nozzle

Daily or after every shift

- Clean the inside and outside of the spray nozzle with compressed air.
Never immerse the parts in solvents!
- Check the seating of the spray nozzles.



WARNING

Make sure that the threaded sleeve is always tightened well. If the spray nozzle is just fitted loosely, there is danger of a flash-over of the gun high voltage, which can damage the gun!

Weekly:

- Remove the spray nozzle and clean on the inside with compressed air. If sinterings should have formed, then they have to be removed!

Monthly

- Check spray nozzle for wear

The flat jet nozzle is to be replaced, if:

- the spray pattern is no longer a regular oval
- deeper grooves are in the nozzle slot, or even the wall thickness is no longer recognizable
- the wedge of the electrode holder is worn

Nozzles with deflectors:

- if the wedge of the electrode holder is worn down, then the electrode holder is to be replaced

Maintenance

The OptiFlex 2 GM03 is designed to require only a minimum amount of maintenance.

1. Clean gun with dry cloth, see chapter "Maintenance"
2. Check connection points to powder house.
3. Replace the powder hoses, if necessary.

Replacing parts

Except for the replacement of possible defective parts, there are very few repairs to be made.



NOTE!

The replacement of the cascade and the repair of the powder gun cable connection is only permitted by an authorized ITW Gema Service center! Contact your ITW Gema representative for details!

Troubleshooting

General information

Event	Causes	Corrective action
H11 (Help code on control unit)	Gun not connected	Connect the gun
	Gun plug or gun cable defective	Contact local Gema representative
	Remote control on powder gun defective	Contact local Gema representative
Gun LED remains dark, although the gun is triggered	High voltage adjustment is set too low	Increase high voltage
	Gun plug or gun cable defective	Contact local Gema representative
	LED on gun defective	Contact local Gema representative
Powder does not adhere to object, although the gun is triggered and sprays powder	High voltage and current deactivated	Check the high voltage and current setting
	High voltage cascade defective	Contact local Gema representative
	The objects are not properly grounded	Check the grounding
The gun does not spray powder, although the control unit is switched on and the gun trigger is pressed	Compressed air not present	Connect the equipment to the compressed air
	Injector or nozzle on the injector, powder hose or powder gun clogged	Clean the corresponding part
	Insert sleeve in the injector is clogged	Clean/replace
	No conveying air: - Throttle motor defective - Solenoid valve defective	Contact local Gema representative
	Front plate defective	Contact local Gema representative

Event	Causes	Corrective action
Gun achieving only poor spray profile	Total air incorrectly configured	Increase the powder quantity and/or total air volume on the control unit
	Bend or damage to air lines to injector	Check air lines to injector
	Insert sleeve in the injector worn or not inserted	Replace or insert it
	Fluidization not running	see above

Spare parts list

Ordering spare parts

When ordering spare parts for powder coating equipment, please indicate the following specifications:

- Type and serial number of your powder coating equipment
- Order number, quantity and description of each spare part

Example:

- **Type** OptiFlex 2 W
Serial number 1234 5678
- Order no. 203 386, 1 piece, Clamp - Ø 18/15 mm

When ordering cable or hose material, the required length must also be given. The spare part numbers for this kind of bulk stock is always marked with an *.

Wearing parts are always marked with a #.

All dimensions of plastic hoses are specified with the external and internal diameter:

Example:

Ø 8/6 mm, 8 mm outside diameter (o/d) / 6 mm inside diameter (i/d)



WARNING!

Only original ITW Gema spare parts should be used, because the explosion protection will also be preserved that way. The use of spare parts from other manufacturers will invalidate the ITW Gema guarantee conditions!

OptiFlex 2 GM03 manual powder gun - Spare parts list

Remarks

1. If a part of the gun body should be broken, or the high voltage cascade in the gun body should be defective, then the whole gun body has to be sent in for repair!
2. If the powder gun cable is defective, it is to be completely sent in for repair!

A	OptiFlex 2 GM03 manual powder gun - complete negative polarity , incl. gun cable - 6 m, rinsing air hose - 6 m, flat jet nozzle, brush and parts kit, without powder hose	1008 070
	OptiFlex 2 GM03 manual powder gun - complete positive polarity , incl. gun cable - 6 m, rinsing air hose - 6 m, flat jet nozzle, brush and parts kit, without powder hose	1008 073
B	Manual powder gun shaft OptiFlex 2 GM03 (incl. cascade) with:	
	Gun cable 2 m, negative polarity (-)	1007 971
	Gun cable 6 m, negative polarity (-)	1007 972
	Gun cable 12 m, negative polarity (-)	1007 973
	Gun cable 2 m, positive polarity (+)	1007 974
	Gun cable 6 m, positive polarity (+)	1007 975
	Gun cable 12 m, positive polarity (+)	1007 968
1	Threaded sleeve - complete	1007 229#
2	Flat jet nozzle NF20 - complete	1007 931#
2.1	Electrode holder - complete	1007 683#
2.2	Flat jet nozzle NF20	1007 934#
	Parts set (not shown), consisting of:	1002 359
	Cleaning brush - Ø 12 mm	389 765
	Flat jet nozzle NF21	1007 935#
	Cable clamp	303 070
	Hose connector – complete, for hose interior Ø 11-12 mm	1001 340
	Powder hose - Ø 10 mm (not shown)	1001 673*#
	Powder hose - Ø 11 mm (not shown)	105 139*#

Wearing part

OptiFlex 2 GM03 manual powder gun - Spare parts list

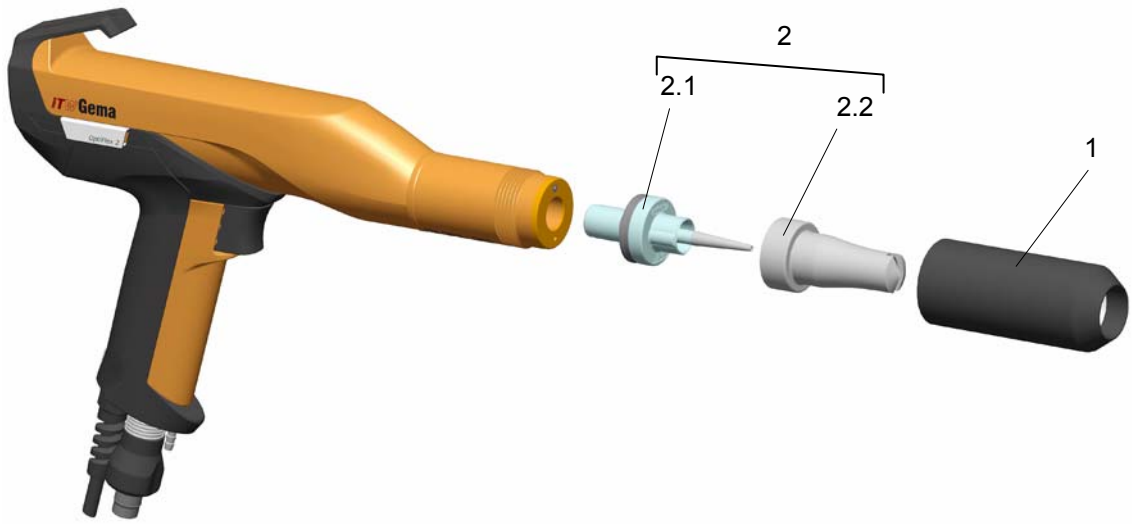

OptiFlex 2 GM03 manual powder gun – spare parts list

PowerClean module

	PowerClean module - complete	1007 362
1	Elastomer valve	1000 089#
2	O ring - Ø 16x2 mm, anti-static	1007 794#
3	Fluidizing tube bearing	1007 356
4	Fluidizing tube	1007 355
5	Stop pin	1007 359
	# Wearing part	

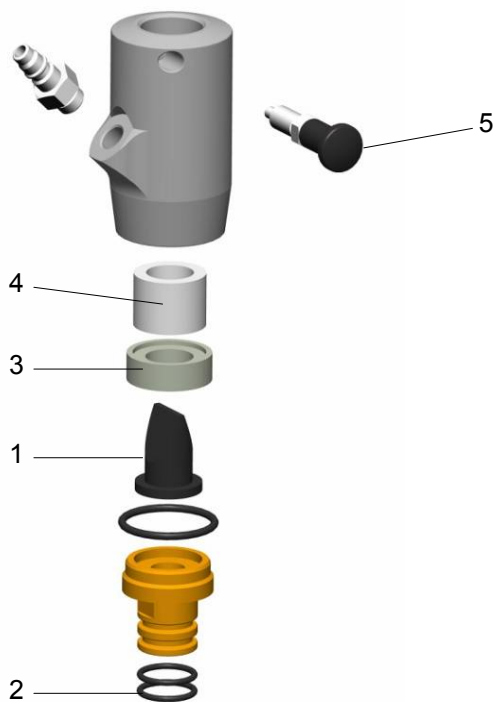

PowerClean module – Spare parts

OptiFlex 2 GM03 manual powder gun - SuperCorona

1 SuperCorona PC05

1008 165#



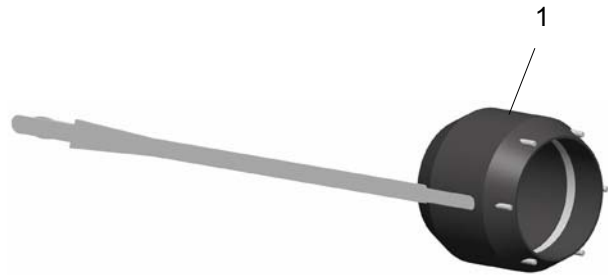

Wearing part





SuperCorona –spare parts

OptiFlex 2 GM03 manual powder gun - accessories



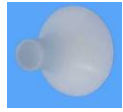

OptiFlex 2 GM03 flat spray nozzles – overview (wearing parts)

Field of application	A	B	A + B	Threaded sleeve
Profiles/flat parts (standard nozzle)	 NF20 1007 934	 1007 683	NF20 1007 931	 1007 229
Complex profiles and depressions	 NF21 1007 935		NF21 1007 932	
Large surfaces	 NF24 1008 147		NF24 1008 142	 1008 326







OptiFlex 2 GM03 rounded spray nozzles – overview (wearing parts)

Field of application	A	B	A + B	Threaded sleeve	Deflectors
Suitable for large surfaces	 NS04 1008 151	 1008 152	NS04 1008 150	 1007 229	
					Ø 16 mm 331 341
					Ø 24 mm 331 333
					Ø 32 mm 331 325
					Ø 50 mm 345 822

OptiFlex 2 GM03 gun extensions

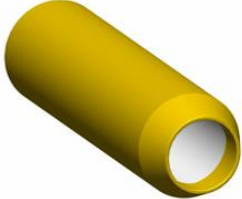
Gun extensions	
without nozzle	with deflector Ø 24 mm
L = 150 mm  1007 718	L = 300 mm  1007 719
 flat jet NF25 1007 746	 1007 747
1007 748	1007 749

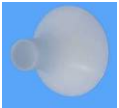

OptiFlex 2 GM03 spray nozzles for extensions – overview (wearing parts)

Field of application	A	B	A + B	Threaded sleeve	Deflectors							
Profiles/flat parts	 NF25 1007 735	 1007 684	NF25 1007 743	 1007 740	--							
Complex profiles and depressions	 NF26 1007 742		NF26 1007 744		--							
Suitable for large surfaces	 NS09 1008 257	 1008 258	NS09 1008 259		 <table border="1"> <tr> <td>Ø 16 mm</td> <td>331 341</td> </tr> <tr> <td>Ø 24 mm</td> <td>331 333</td> </tr> <tr> <td>Ø 32 mm</td> <td>331 325</td> </tr> <tr> <td>Ø 50 mm</td> <td>345 822</td> </tr> </table>	Ø 16 mm	331 341	Ø 24 mm	331 333	Ø 32 mm	331 325	Ø 50 mm
Ø 16 mm	331 341											
Ø 24 mm	331 333											
Ø 32 mm	331 325											
Ø 50 mm	345 822											

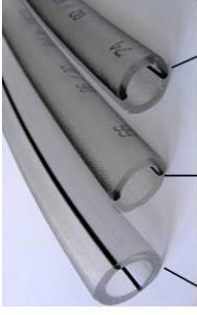
Powder hoses - overview

Powder hose	Field of application	Diameter	Parts No.	Material	Type	Remarks
 <p> Ø 12/18 mm Typ. 75 Material POE </p> <p> Ø 11/16 mm Typ. 66 Material POE </p> <p> Ø 10/15 mm Typ. 74 Material POE </p>	Fast color switches	Ø 11/16 mm	105 139	POE	66	antistatic
	Fast color switches – low powder flow	Ø 10/15 mm	1001 673	POE	74	antistatic
	Fast color switches – High powder flow	Ø 12/18 mm	1001 674	POE	75	antistatic

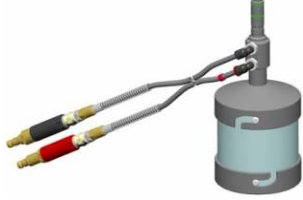
Other accessories

Application cup	<p>150 ml</p>  <p>1004 552</p>	<p>500 ml</p>  <p>1002 069</p>
Gun extension cables	 <p>L=6 m 1002 161 L=14 m 1002 162</p>	
Antistatic gloves (1 pair)	 <p>800 254</p>	

OptiFlow injector

Structure

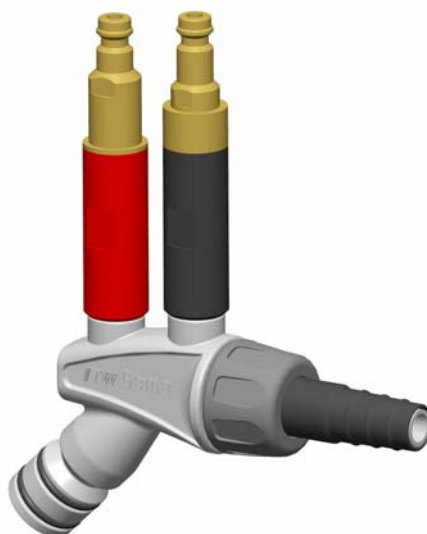



OptiFlow Powder injector (type IG06) with coded quick release connections



Note:

The injector is certified for using in the following zone, if powder hoses with conductive strips are used, and the earthing resistance is less than 1 MOhm!

Explosion protection	Zone
 	22

Powder volume setting for OptiFlow Injector

In order to set the ideal powder volume on the gun control unit, it is recommended to select the firmness of the powder cloud or the total air first. As guide values for different powder hoses, the following can be assumed:

- Powder hose 74 type, Ø 10 mm, **3-5 m³/h**
- Powder hose 66 type, Ø 11 mm, **4-5 m³/h**

According to the prevailing conditions (powder, powder hose layout, the parts to be coated) a low to lowest total air can also be set with the standard hose 74 type, Ø 10 mm.

If a very large powder output is required, it is recommended to select a larger powder hose internal diameter (Ø 12 mm).



Note:

It should be noted, that if irregular or pumping conveying occurs, as a rule, the total air is set too low!

Cleaning and maintenance

Cleaning the injector

1. Remove the injector
2. Remove the powder hose from hose connection (4)
3. Clean the hose connection (4) with compressed air which is free of oil and water, and check for wear
4. Clean the injector body (1) with compressed air which is free of oil and water. Possible contaminations are visible through the opening of the powder hopper connection (2)
5. Reinsert the injector and fix it



WARNING!

If the injector is severely contaminated, it must be dismantled. Remove the non-return valve units (6 and 7) with the correct sized spanner. Clean the component parts with compressed air and, if necessary, dissolve sintered deposits with nitro-thinner. Do not use acetone, do not scrape!

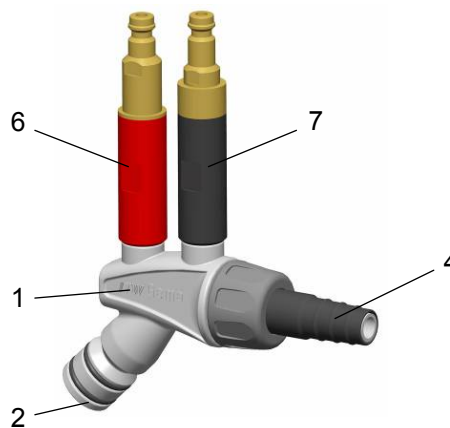

- | | | | |
|---|--------------------------|---|---|
| 1 | Injector housing | 6 | Non-return valve unit (conveying air) |
| 2 | Powder hopper connection | 7 | Non-return valve unit (supplementary air) |
| 4 | Powder hose connection | | |

Cleaning the non-return valve units



Note:

Take care when dismantling the non-return valve units!
Blow off the filter elements from the inside to the outside!

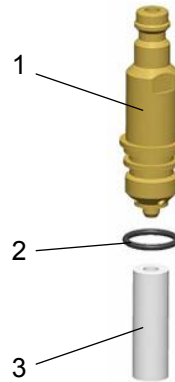

- 1 Connection/plug
- 2 O-ring
- 3 Filter element



Note:

Do not immerse the filter elements in fluidities or solvents!!!

Replacing the insert sleeve

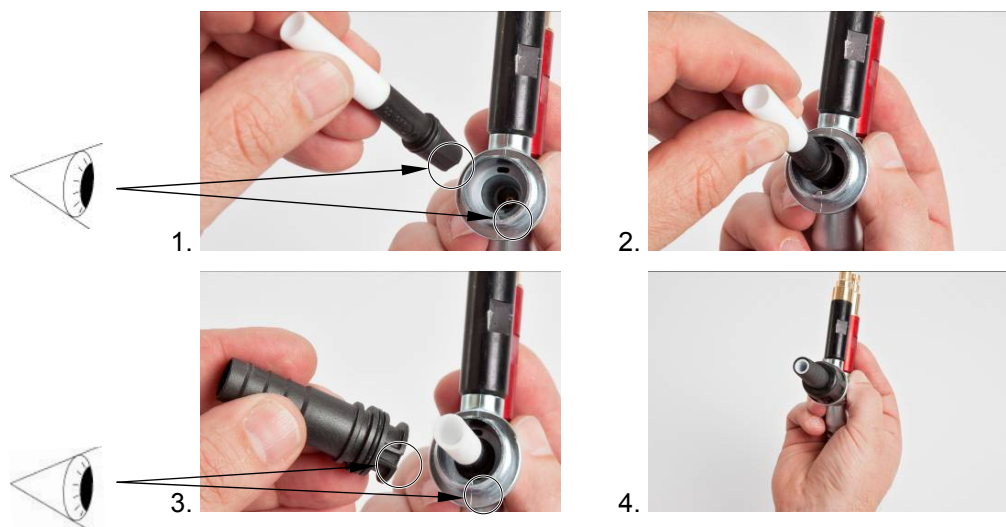

Troubleshooting guide

Problem fixing

If the powder gun does not spray powder although the control unit is switched on, then the injector can be dirty or clogged.

Error/cause	Troubleshooting
Injector nozzle, non-return valve unit, powder hose or powder gun are clogged	Clean the corresponding parts and if necessary, replace them
Conveying vacuum too low	Increase the powder quantity and/or total air volume on the control unit
Insert sleeve worn, not or incorrect inserted	Replace or insert it, observe the indexing cam
Insert sleeve is worn after a short operating duration	Clean the nozzle, if damaged, replace it

Spare parts list

Ordering spare parts

When ordering spare parts for powder coating equipment, please indicate the following specifications:

- Type and serial number of your powder coating equipment
- Order number, quantity and description of *each* spare part

Example:

- **Type** OptiFlex 2 W
Serial number 1234 5678
- Order no. 203 386, 1 piece, Clamp - Ø 18/15 mm

When ordering cable or hose material, the required length must also be given. The spare part numbers for this kind of bulk stock is always marked with an *.

Wearing parts are always marked with a #.

All dimensions of plastic hoses are specified with the external and internal diameter:

Example:

Ø 8/6 mm, 8 mm outside diameter (o/d) / 6 mm inside diameter (i/d)



WARNING!

Only original ITW Gema spare parts should be used, because the explosion protection will also be preserved that way. The use of spare parts from other manufacturers will invalidate the ITW Gema guarantee conditions!

OptiFlow Powder injector (type IG06)

OptiFlow IG06 Powder injector - complete (pos. 1-13)		1007 780
A	Conveying air check valve unit (red marking) - complete (incl. pos. 6, 8, 9 and 12)	1005 589
B	Supplementary air check valve unit (black marking) - complete (incl. pos. 7, 8, 9 and 13)	1005 590
C	Injector body - complete (incl. pos. 1, 2, 10 and 11)	1006 530
1	Injector body (without pos. 2)	1006 484
2	O-ring - Ø 16x2 mm	1007 794#
3	Insert sleeve - Teflon, complete	1006 485#
4	Hose connection - Ø 10-12 mm, complete (incl. pos 4.1)	1006 531
4.1	O-ring - Ø 16x1.5 mm	205 141#
5	Threaded sleeve	1006 483
6	Connector (conveying air) - NW 5.5	1004 366
7	Connector (supplementary air) - NW 5.5	1004 367
8	O-ring - Ø 11x1.5 mm	1000 532#
9	Filter element - Ø 9/4x27 mm	1003 698
10	Nozzle	1006 488
11	Nozzle fixation - complete (incl. pos. 11.1)	1007 792
11.1	O-ring - Ø 8x1 mm	1007 793#
12	Body (red)	1004 369
13	Body (black)	1004 370
16	Conveying air hose - Ø 8/6 mm (red)	103 500*
17	Supplementary air hose - Ø 8/6 mm (black)	1008 038*
18	Quick release coupling for conveying air hose - NW5-Ø 8 mm	261 645
19	Quick release coupling for supplementary air hose - NW5-Ø 8 mm	261 637
	Powder hose - 66 type, POE, Ø 16/11 mm, with conductive strip (standard)	105 139*#
	Powder hose - 74 type, POE, Ø 15/10 mm, with conductive strip	1001 673*#
	Powder hose - 75 type, POE, Ø 18/12 mm, with conductive strip	1001 674*#

* Please indicate length

Wearing part

OptiFlow Powder injector (type IG06)

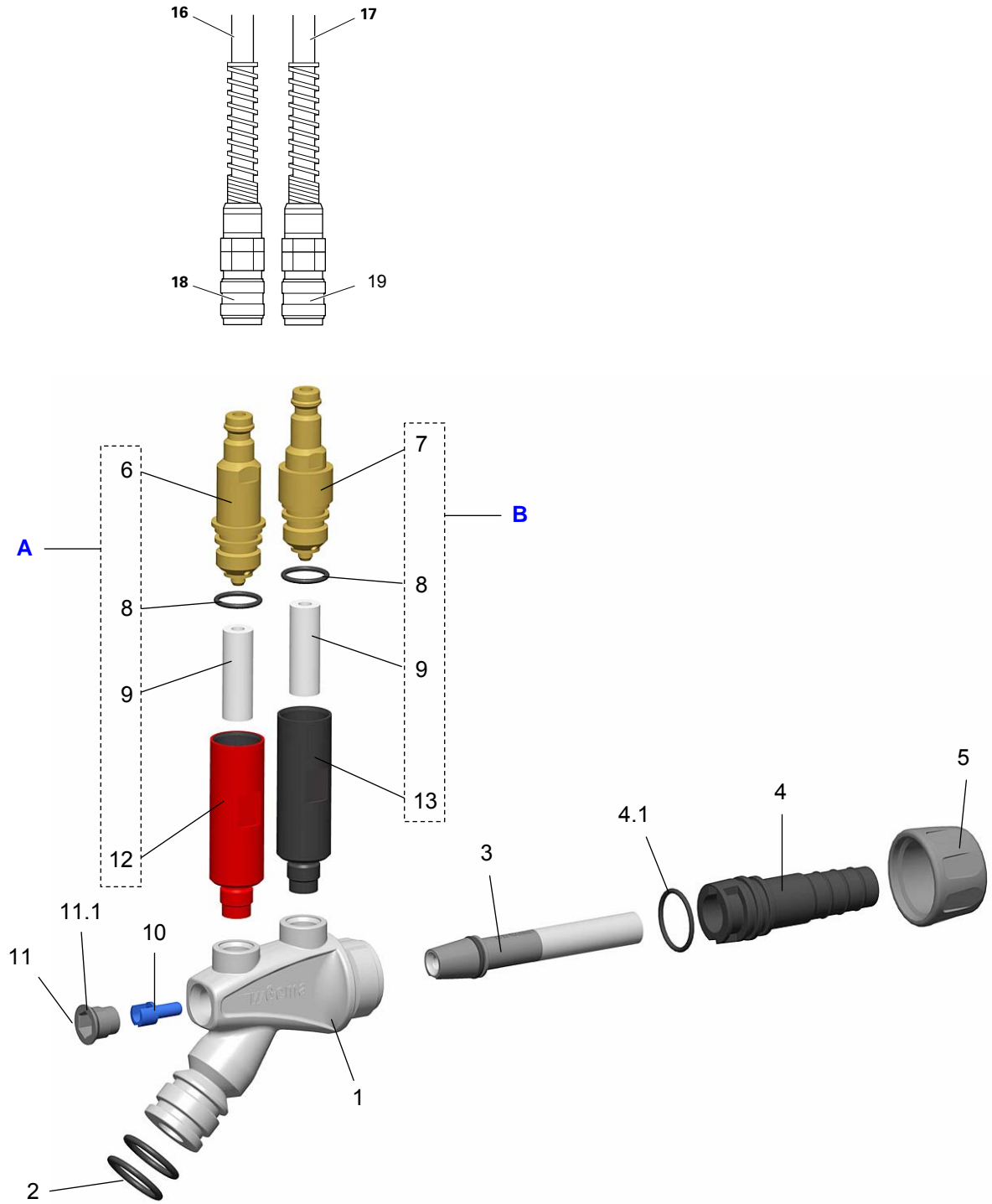

OptiFlow Powder injector (type IG06)